

C L A R I T Y
T H R O U G H
P O W E R

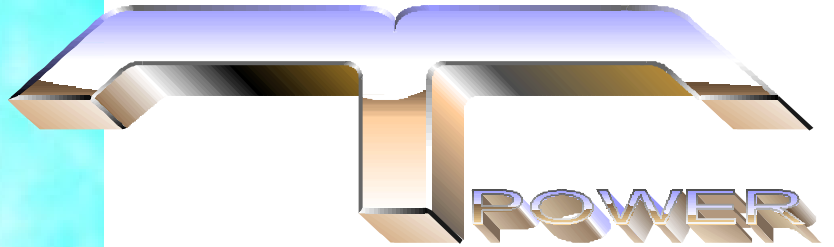

a new generation of
audio capacitors from

BHC Aerovox LTD.



Audio Applications PCB mounted

The T-Network capacitor is a unique capacitor designed specifically for Audio applications. Its main advantage lies in its ability to reduce unwanted resistance and inductance producing a signal closer to pure capacitance.



Capacitance range	10,000µF
Capacitance tolerance	50V -10+30% 63V ±20%
Voltage range	50V and 63V
Temperature range	-40°C to +85°C
Case size	40Ø x 55L

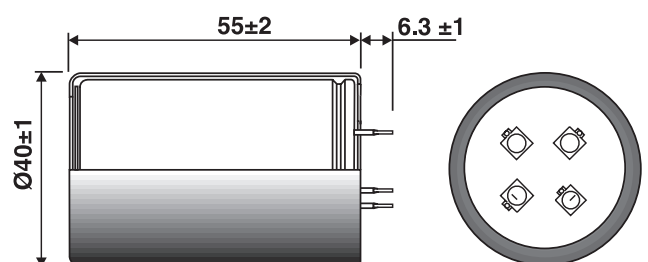

C L A R I T Y
T H R O U G H
P O W E R

A normal power reservoir capacitor combines the input and output in common current paths. This produces resistance generated transient voltages, during the charging cycle, as the transient charging current mixes with the outgoing load current.

In a normal capacitor unwanted resistance and inductance force the input and output together electrically, making its unwanted characteristics very critical for good performance - figure 1.

Figure 1: Conventional capacitor

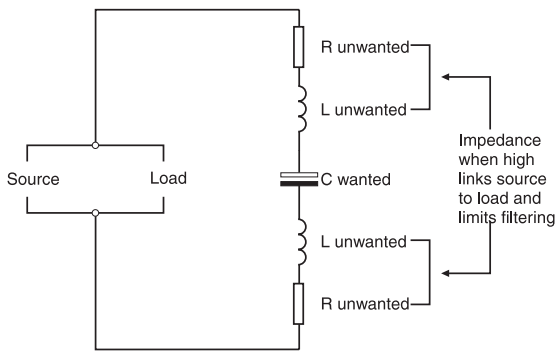

The new T-Network capacitor (TNC) behaves differently because the input must flow along the capacitor plate to reach the output. The signal is forced into pure capacitance with most of the unwanted resistance and inductance appearing on each side of the bulk capacitance. The residual component defects therefore tend to assist capacitive filtering in the T-Network design. - figure 2.

Figure 2: T-Network Capacitor

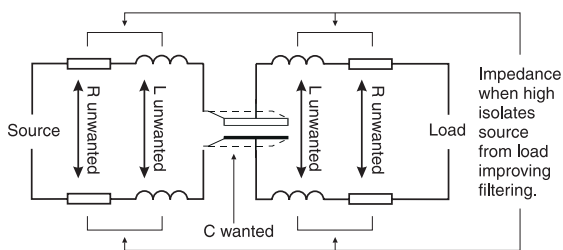

In the TNC, separation of the input and output currents is maintained through the connecting terminals and along the internal tabs onto the capacitor plates. Due to the unique current routing, the separation is still effective during emission into the electrolyte.

The input currents are split equally in the foil plate and they travel only half the winding length. Displacement currents in the foil are therefore zero at the point where the output is taken from the plate. Even under high current conditions path resistance cannot cause voltage intermodulation between source and load.

Tests have shown that the split input/output pathways of the new TNC allow peak current limiting to be used on bridge rectifiers without any loss of performance. The current limiting resistance damps rectifier diode resonances that cause high frequency radiation back into the mains supply - figure 3.

Figure 3: TNC in the Bridge Rectifier

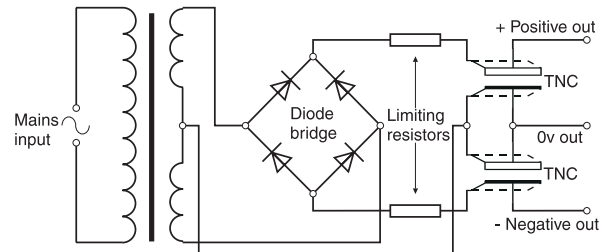

Most significantly, at this time, the TNC may help manufacturers meet the EMC standards.

The TNC is designed for the most demanding filtering situations and it will redefine performance standards in many non-audio applications. In audio amplifiers TNC technology can be combined with Slit Foil technology to produce the ultimate audio capacitor. These capacitors give excellent results against standard components on a direct replacement. However, TNC high frequency performance is so enhanced that the H.F. compensation of test amplifiers may need resetting for best results.

T-Network Series capacitor performance

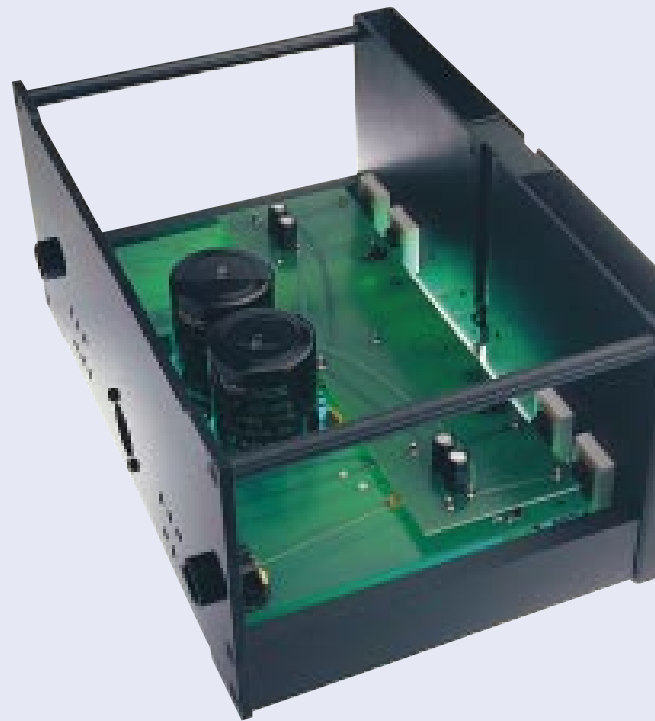

A typical reservoir capacitor size of 10,000 μ F, 50V in TNC form was compared with a two terminal, conventional capacitor, of identical design using a Network Analyser, calibrated for 4 port S parameter impedance measurements. Each capacitor was driven at a calibrated level from a 50 ohm source into a 50 ohm load and the load attenuation achieved was displayed against frequency between 10kHz and 100MHz. A simplified representation of the displayed result is shown in figure 4.

Figure 4: TNC Load Attenuation

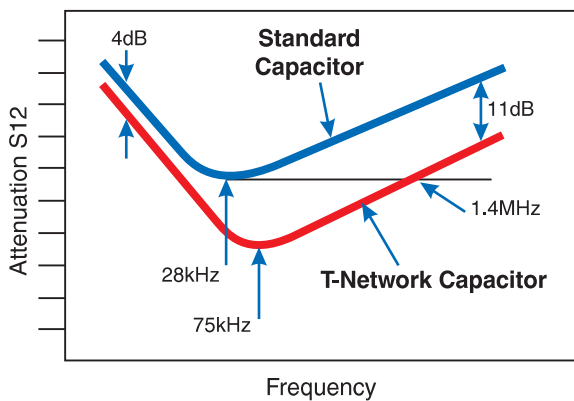

The standard capacitor showed increasing attenuation (input to output) from 10kHz up to 28kHz. Its attenuation then bottomed out and decreased, due to inductance, as the sweep frequency increased.

The TNC was 4dB better in attenuation at 10kHz and it kept attenuating until 75kHz where it reached its maximum attenuation. At this point it is 11dB better than the standard capacitor.

The continuing sweep towards higher frequencies showed decreasing attenuation due to inductance but always retaining the 11dB advantage over the standard capacitor. The TNC did not deteriorate to the best attenuation of the standard capacitor until 1.4MHz.

The TNC performance improvement is large enough to enable an improved product specification to be quoted in its various applications. The TNC will, in some cases, replace several large components with a single, more effective, one.

Designing in the T-Network

The TNC installation requires the bridge rectifier diode feed to be separated from the output of the reservoir capacitors. Similarly the transformer centre tap (in a split rail design) is separated from the reservoir centre tap. If the TNC is to be used as an upgrade option it is possible to design a PCB dual footprint to accept conventional and TNC components on the same PCB.

BHC Aerovox, in conjunction with DNM Design, will be pleased to help designers with any installation and design enquiries.

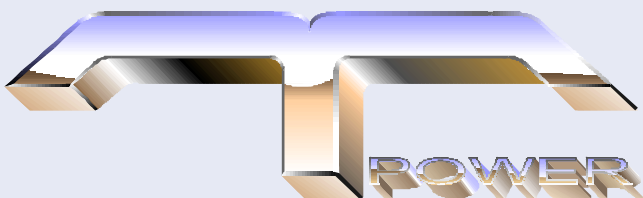

The TNC Symbol

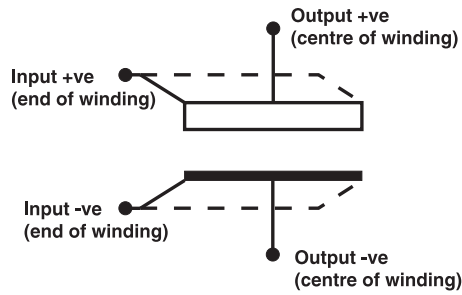

Mounting details

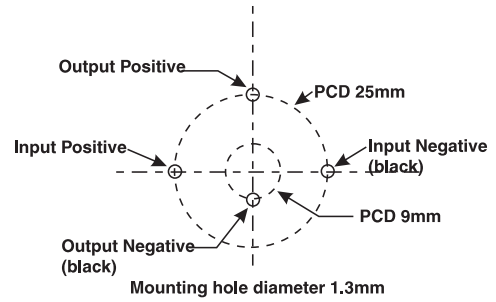

Rated Voltage	Surge Voltage	Cap μF	ESR mW at 20°C, 100Hz	Impedance mW at 20°C, 10KHz	Ripple Current A at 85°C, 100Hz	Type Number
50	57.5	10000	30	21	8.69	ALN20S1053DD
63	72.5	10000	20	16	8.43	ALN20S1067DD

Note: Values of E.S.R. and impedance quoted above are maximum

Technical data

Related documents

IEC 384-4

Temperature range

Storage -55°C to +85°C

Operating -40°C to +85°C

Environmental classification 40/085/56

Surge voltage

1000 surges (30 seconds) at 85°C with surge voltage applied.

Charge/discharge

10^6 cycles at 25°C and rated voltage. One cycle per second with a time constant of 0.1.

D.C. leakage current

After application of rated d.c. voltage for 5 minutes at 20°C, the d.c. leakage current shall not exceed $(0.006 C_R U_R + 4) \mu\text{A}$. Where C_R is the rated capacitance in μF and U_R is the rated d.c. voltage.

Vibration

10Hz to 500Hz at 0.75mm or 10g for 3x2hrs duration.

Insulation resistance

$\geq 100\text{M}\Omega$ at 100V d.c., across insulating sleeve.

Voltage proof

$\geq 2500\text{V}$ d.c., across insulating sleeve.

Ripple current

The following values are approximate only, to give an indication of the effects of frequency and temperature on ripple current. More accurate data can be obtained by referring to the Application Notes available from BHC Aerovox.

FREQUENCY CORRECTION

Capacitors shall withstand the rated r.m.s. ripple current as given in the tables at upper category temperature in circulating air. For frequencies other than those shown the following multipliers should be applied to the 100Hz ripple current.

FREQUENCY (Hz)

50	100	500	1k	$\geq 10\text{k}$
0.81	1.0	1.28	1.33	1.39

TEMPERATURE CORRECTION

For ambient temperatures other than 85°C the following correction factors should be employed.

AMBIENT TEMPERATURE FACTOR

30°C	2.5
50°C	2.1
70°C	1.6
85°C	1.0

N.B. The sum of the d.c. and a.c. voltage components should not exceed the d.c. voltage rating.

Life expectancy

26,000 hours at rated temperature with rated voltage and ripple current applied.

Capacitor marking

The capacitors are marked with items 1 to 7 from the following list.

1. Rated capacitance in μF
2. Tolerance on rated capacitance
3. Rated voltage d.c.
4. BHC part number
5. Polarity of terminations
6. Patent number
7. Date code/Batch code

Patent Number: PCT/GB95/00213

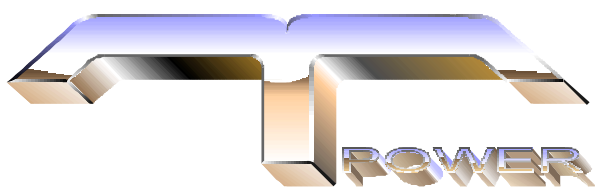

**a new generation of
audio capacitors from**

BHC Aerovox LTD.

BHC Aerovox Ltd.
20-21 Cumberland Drive
Granby Industrial Estate
Weymouth
Dorset DT4 9TE
United Kingdom

Telephone +44 (0)1305 782871
Fax +44 (0)1305 760670
Email sales@bhc.co.uk.
Web site www.bhc.co.uk

Aerovox
740 Belleville Avenue
New Bedford
MA 02745-6194
U.S.A.

Telephone +1 508 994-9661
Fax +1 508 999-1000